

Product Data Sheet Type: SI488

Group: ACCESSORIES Thermal Interface Material

Silicone washers

Electrical insulating :	2,5 kV
Thickness :	0,18
Dielectriccoefficient :	2,56 at 1MHz
Minimum thermal resistance :	1,5 K/W
For device :	TO 220
Device mounted by :	Screw
Material :	Silicon w. Glasfibre

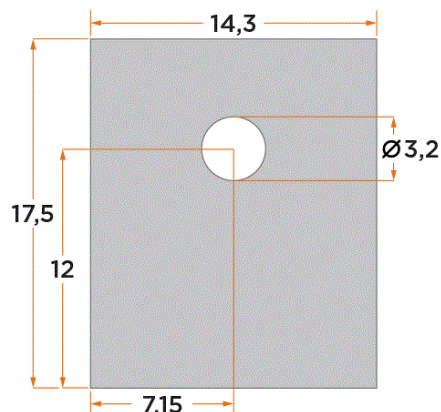

Glass fibre reinforced silicone foil in combination with insulating bushes facilitate insulated mounting of semiconductors e.g. on heatsinks. They are highly flexible and ensure optimal heat conductivity even without using thermal compounds.

- Colour: grey
- Hardness: (Test ASTM D 2240) 85 Shore A
- Elongation: (Test ASTM D 412) 2%
- Tolerance: +/- 0,02 mm
- Temperatur range: -60 / +200 °C
- Thermal Conductivity: 0,9 W / mK
- UL listed
- Thickness: 0,18 mm
- Rth: 0,33 K/W
- Dielectric strength: app. 4 KV
- Dielectric constant: 2,56 (at 10⁶ Hz)

